

The Sun in Tetrapylons

A Report on
Discovering the Relationship between Tetrapylons, Time
and Variation in the Declination of the Sun

The background of the cover features a silhouette of a tetrapylon, a four-arched structure, against a sunset sky. The sun is visible as a bright orange and yellow orb in the right-hand arch. The sky transitions from a deep blue at the top to a lighter orange near the horizon.

Ketabton.com

Persian Studies

Reza Moradi Ghiasabadi

Persian Studies

The Sun in Tetrapylons

A Report on Discovering the Relationship
between Tetrapylons, Time and Variation in the
Declination of the Sun

By:

Reza Moradi Ghasabadi

Translated by:

Bahareh Eskandari



2015

Published with permission of the author:
<http://ghiasabadi.com/the-sun-in-tetrapylons.html>

First Edition 2015
Lithography & Print
Naqsh-e Tavoos/ Tavoos Rayaneh
*

www.ghiasabadi.com / reza@ghiasabadi.com

© 2015, Reza M. Ghiasabadi
All rights reserved

ISBN 978 964 6303 50 8

Printed in Iran

Contents

Translator's Preface	7
Part I The Persian Tetrapylons	9
1 Preface to the First Part	11
2 The Tetrapylon: Definition, Types, and Scattering	15
3 Niasar Tetrapylon	17
4 Botkhaneh Tetrapylon	34
5 Nevis Tetrapylon	40
6 Kheyrabad Tetrapylon	44
7 Kermejegan Tetrapylon	46
8 Kahak Tetrapylon	48
9 Khworabad Tetrapylon	52
10 Khaneh-e Div Tetrapylon	54
11 Photos of Some Other Tetrapylons	58
Part II The Roman Tetrapylons	69
12 Preface to the Second Part	71
13 Heidentor Tetrapylon	73
14 Caparra Tetrapylon	76
15 Janus Tetrapylon	78
16 Malborghetto Tetrapylon	80
Appendix	83

The Sun in Tetrapylons

Translator's Preface

Reza Moradi Ghasabadi is a well-known Iranian researcher with a novel insight into History and Archaeology. After becoming familiar with his works, I asked him to let me translate the report of one of his research projects explaining his theory on the functionality of the Persian tetrapylons as solar structures. This theory has been confirmed by some experts and many evidences, validating it, have been found. The first part of this book is the translation from the last Persian edition of the book *The Persian Tetrapylons* published in 2010. The second part of this book is published herein for the first time except Chapter 13, Heidentor Tetrapylon, which has been published as a paper in Journal of Persia Digest (2012).

Ghasabadi begins *The Persian Tetrapylons* with an old poem: "That building on the hillside is a place for time and time measurement." This poem is from *Shahnameh*, authored by *Ferdowsi*, who is the greatest Persian epic poet in the tenth century AD. Ferdowsi narrates the ancient historical-storied events of Iranian people in *Shahnameh*. Ferdowsi quotes the mentioned poem from *Zal*, who is a Persian mythological character whose functions relate to the time and *Zurvan*. In fact, Ghasabadi starts his book with a thousand-year-old poem which describes a building on a hillside with calendrical functionality, so this poem can be an allegory of a tetrapylon.

The book mentions to the terms of *Mithra* and *Zurvan*. For non-Persian-speaking readers, these two terms are defined here.

Zurvan in the *Avestan language* (one of the old Iranian languages) means time. Afterwards, this term became a name for the great

The Sun in Tetrapylons

god who is the creator of the universe. *Saturn* was referenced as the embodiment of Zurvan. The Saturn's Greek name *Cronus* or *Kronos* is also associated with the time and its concept.

Ghiasabadi believes that the original concept of *Mithra* refers to the ecliptic pole, Pole Star, and consequently to the *eternal light*; however, the *eternal light* became equivalent to the sun as the great god and the creator. Mithra was the great god of *Mithraism* which was common in Persia and Roman about two thousand years ago. Beliefs and customs in Mithraism had crucial influences on Christianity such as using the red color, Cedrus, and star as sacred signs; celebrating Christmas which coincides with the winter solstice and the new year; and becoming the shape of the cross (which results from rotating constellations of *Ursa Major* and *Ursa Minor* known as the *Chariot of Mithra*) as the Cross of Jesus.

On behalf of Ghiasabadi, this book is dedicated to all those interested in archaeological Persian researches.

Bahareh Eskandari

March 2014

Part I
The Persian Tetrapylons

1 Preface to the First Part

This book reports the discovered relationships between tetrapylons, time, calendars, the sun, and the variation in the declination of the sun which are based on field studies and tangible observations. In the science of Archaeoastronomy¹, the buildings with such characteristics are called *solar observatory* or *solar structures* (*calendar buildings*) in English and *kalenderbauten* in German. In Persian language, a tetrapylon is called *chartaqi* or *chabartaqi* meaning a building with four arches. In addition, there are some Persian names e.g. *Mehrbin* (means the place to see *Mehr*), *Khwarbin* (means the place to see the sun), and *Bazeh-e Hur* (means an opening for the sun), which they have been used to call these buildings for centuries and are known in the Persian language. It is possible that these appellations are ancient names with forgotten meanings for solar structures.

In some types of tetrapylons, the orientation and shape of the building, the ratio of the length of pillars to the distance between them, and the angles between pillars make the rays of sunlight shine on particular directions of the building at specific times of

¹ Archaeoastronomy is a new interdisciplinary science which involves archaeology, astronomy, anthropology, and ethnology. This science deals with the influence of sky phenomena and movement of astronomical objects on arts, rituals, religions, beliefs and other cultural events of ancient people. Archaeoastronomy has different branches and scientific fields such as cosmological, mythology ethnoastronomy, and astronomical architectonics. Studies on calendar systems, time measurement and astronomical instruments of the ancient world are also other fields of studies in archaeoastronomy.

The Sun in Tetrapylons

the year at sunrise and sunset. These rays create shade at individual points inside the structure and some of them identifying important temporal events are seen between pillars.

Since 1993, starting archaeoastronomical researches, I have studied approximately 50 tetrapylons in order to investigate the possible relationships between the variation in the sun's declination and calendrical functionality of the tetrapylons. In 1995, Niasar Tetrapylon as the most intact tetrapylon in Iran was selected to focus for field studies. In subsequent years, Nevis and Botkhaneh Tetrapylons were also chosen for this purpose.

Over the past years, the necessary measurements for horizon were examined, and it was tried to compare the crucial directions of tetrapylons to the variation in the sun's declination. Initial calculations, field studies, and annual multiple trips were the necessities of this research project, which reaching reliable conclusions lasted over eight years and its studies still continue.

So far, the way the tetrapylons have been built, and the principles used in their construction have been known relatively. These principles rely on time, solar annual motion, and variation in the declination of the sun. Although we are aware of the capability of tetrapylons as solar structures and indicators to measure time or record ritual time, there are still many unknowns about how tetrapylons operate for measuring the time, so clarifying the ambiguities needs many years to be solved.

Today not only the sightlines of the sunrise and sunset in the summer and winter solstice with an accuracy of about one degree, but also several other sightlines with a lower accuracy have been measured in Niasar Tetrapylon. Studies and annual observations are being pursued in the Niasar, Nevis, Botkhaneh Tetrapylons, and some similar tetrapylons in different parts of Iran to examine directions more precisely, find significant points in the solar motion on the horizon and their possible relationships with the tetrapylons, study to know calendar systems at the time of constructing the tetrapylons, and most of all to consider the

The Sun in Tetrapylons

possibility of directions relative to ritual moments and ancient ceremonies especially in connection with Zurvanism and Mithraism.

Nowadays, there are serious concerns over deteriorating conditions of some tetrapylons in Iran and Niasar Tetrapylon as well. As a result, if this important tetrapylon is damaged severely, there is not another building that can be replaced.

This book solely describes the calendrical features and solar indicators of tetrapylons; therefore, the book does not include other possible functions of tetrapylons due to the deficiency in written sources or observed evidences. There are speculations that these types of buildings functioned as temples of the sun, Mithraic temples, or temples of Zurvan; however, these assumptions cannot be propagated until a few evidences are found. In addition, it was not heard convincing folk tales among people's beliefs and narratives.

For ages, there has been a wrong or at least not proven statement, which calls the Persian tetrapylons as fire temples. This is a claim that archaeological evidences still have not been found in any tetrapylons in Iran to attest it. Furthermore, these buildings which are usually located in remote parts of the country do not have doors, walls and private areas; consequently, it seems that the design of tetrapylons does not fit to be fire temples. In fact, there is not any contradiction between what has been discussed in this book on calendrical characteristics of tetrapylons and other possible functions of tetrapylons such as being temples, fire temples, etc. Furthermore, the term *tetrapylon* (*chartaqi* in Persian) indicates the shape of these buildings, but not their functions.

My reports with regard to the functions of tetrapylons as solar structures and indicators have been published in different papers, conference proceedings, and interviews (e.g. Press conference, University of Tehran, 1999; Avesta in the History and Culture of Central Asia, Tajikistan, 2001; The First National Congress on Iranian Studies, Tehran, 2002) in Persian, English, and Russian. In

The Sun in Tetrapylons

addition, the reports have been broadcast on several radio and TV programs.

The following books: *The Calendar System of Persian Tetrapylons* (2001), *The Calendar Buildings in Iran* (2004), and *Persian Tetrapylons* (2010) have been published on tetrapylons and their calendrical functions.

2 The Tetrapylon: Definition, types, and scattering

A tetrapylon is a type of building of a cubic shape with a square base. It consists of four pillars, four arches and a dome which is constructed by four squinches.

Tetrapylons have both a specific and general definition. In the specific definition, tetrapylons are unique individual buildings with approximately 2000 years old. They can be seen in different parts of Iran and as mentioned before are known by the terms of *chartaqi* or *chabartaqi*. Persian tetrapylons are independent large buildings without other architectural elements. They do not have surrounding walls and even doors and windows.

Tetrapylons are generally located in the western half of Iran, central and southwestern provinces, and especially in the south of Fars Province, but the scattering of the tetrapylons in the eastern half of Iran is very limited.

On the contrary, there are other types of buildings, which are confused with unique tetrapylons with the specific definition because of many similarities to each other. Although these buildings in appearance resemble the tetrapylons, there are significant differences between them. These quasi-tetrapylons which are simple small constructions, have usually been built in recent centuries. They have been established as architectural canopies, garden homes, mausoleum tombs, and other ordinary uses. Moreover, in cities of Ardestan, Zavareh, and some others located in southern parts of the central desert area, windcatchers that resemble the tetrapylons are constructed on roofs and are called *chartaq*.

The Sun in Tetrapylons

In general definition, the tetrapylon refers to an architectural style. In this style, the central part of a building that consists of four pillars, and four arches is known as the *chartaqi* or *chartaq architectural* style. This type of buildings is seen in many ancient structures such as palaces, mosques, shrines, temples, churches, etc. that the design of their central areas falls under the Chartaq architectural style.

It is necessary to mention that the central parts of some quasi-tetrapylons were really the unique tetrapylons which have been expanded over years, and other buildings have been added to them. The number of these evolved tetrapylons is great, and it is difficult to identify them easily because the main parts of the tetrapylons have been changed due to newer constructions and added architectural elements. (For example, refer to Kahak Tetrapylon in this book).

The Sun in Tetrapylons

3 Niasar Tetrapylon

Location: The village of Niasar, 30 kilometers west of Kashan City, about 250 kilometers south of Tehran (the Iran's capital)

Geographic coordinates: $33^{\circ} 58.28'$ north latitude and $51^{\circ} 08.53'$ east longitude



Figure 3.1: Niasar Tetrapylon, the western view

The Sun in Tetrapylons

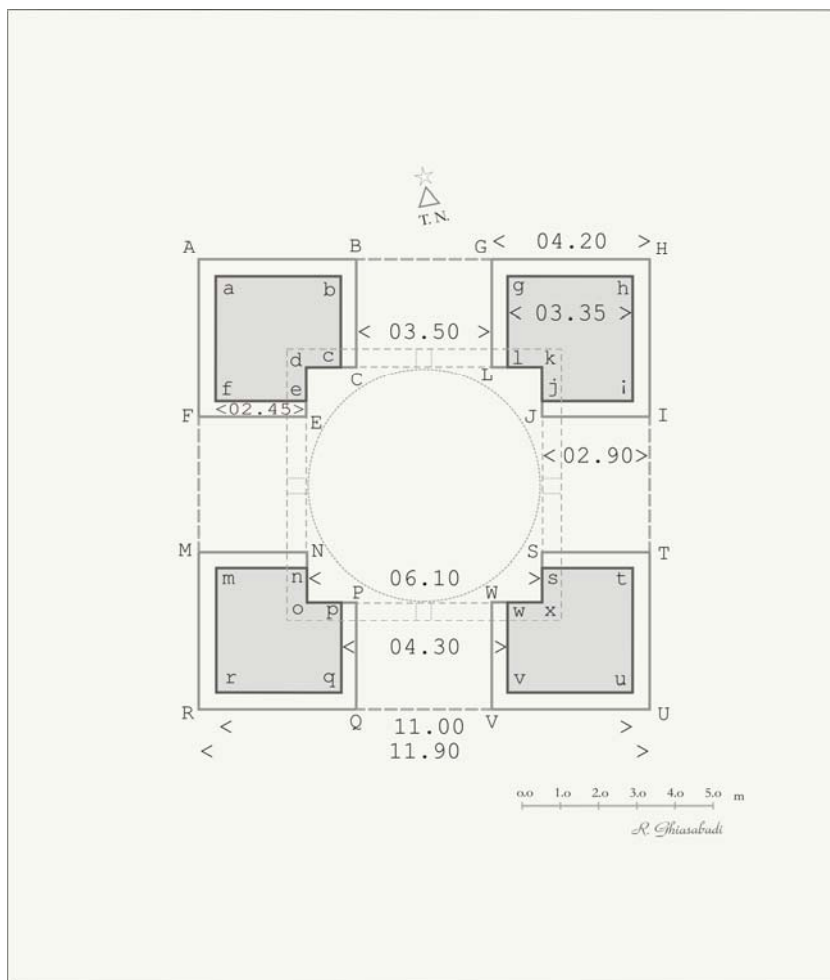

Figure 3.2: The floor plan of Niasar Tetrapylon

The Sun in Tetrapylons



Figure 3.3: Inside Niasar Tetrapylon, the shape of pillars, and the northeastern view.

Outer surface of the floor was paved in 1955.

The Sun in Tetrapylons

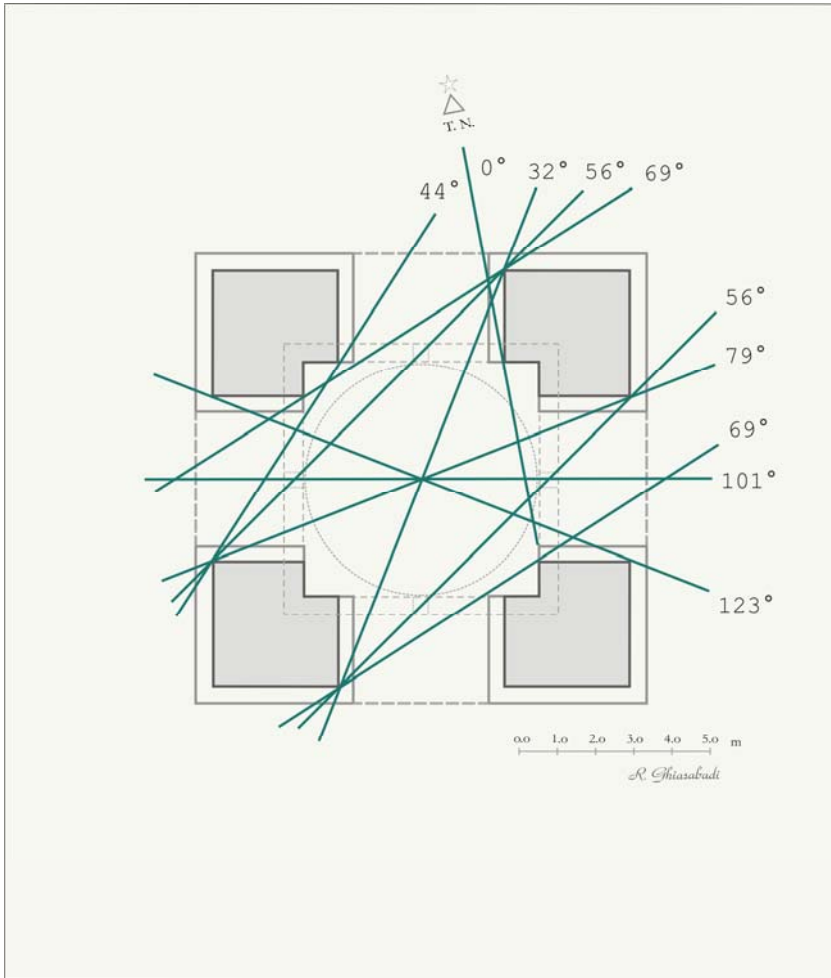

Figure 3.4: The angles created by the sightlines (between pillars) based on the declination angle for the true north

The Sun in Tetrapylons

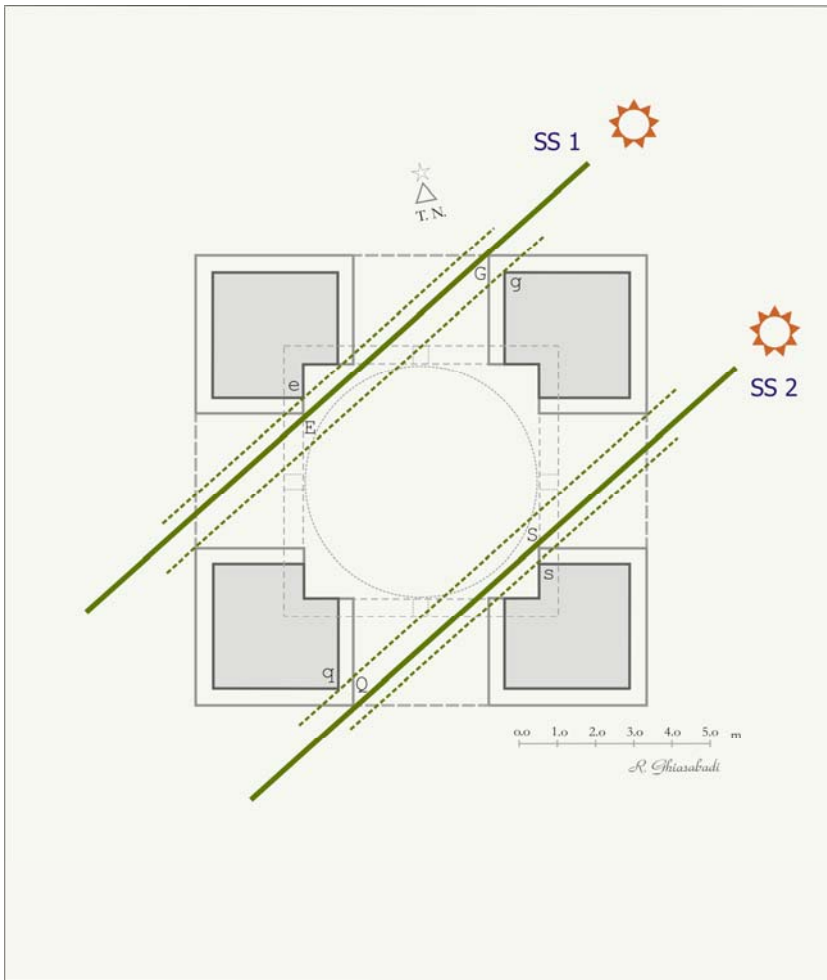

Figure 3.5: Double sightlines of sunrise in the summer solstice: continuous lines show the limits of observing the sun one meter above the ground level where the pillars are wider (at the bench-like parts of the pillars), whereas the dotted lines show the limits of observing the sun in the narrower upper parts of the pillars.

The Sun in Tetrapylons



Figure 3.6: Sunrise in the summer solstice: the sightline is SS 1 in Figure 3.5, around 10 minutes after the sunrise.

The Sun in Tetrapylons



Figure 3.7: Sunrise in the summer solstice: the sightline is SS 2 in Figure 3.5, around 5 minutes after the sunrise.

The Sun in Tetrapylons



Figure 3.8: Sunrise in the summer solstice: the sightline is SS 2 in Figure 3.5, around 10 minutes after the sunrise.

The Sun in Tetrapylons

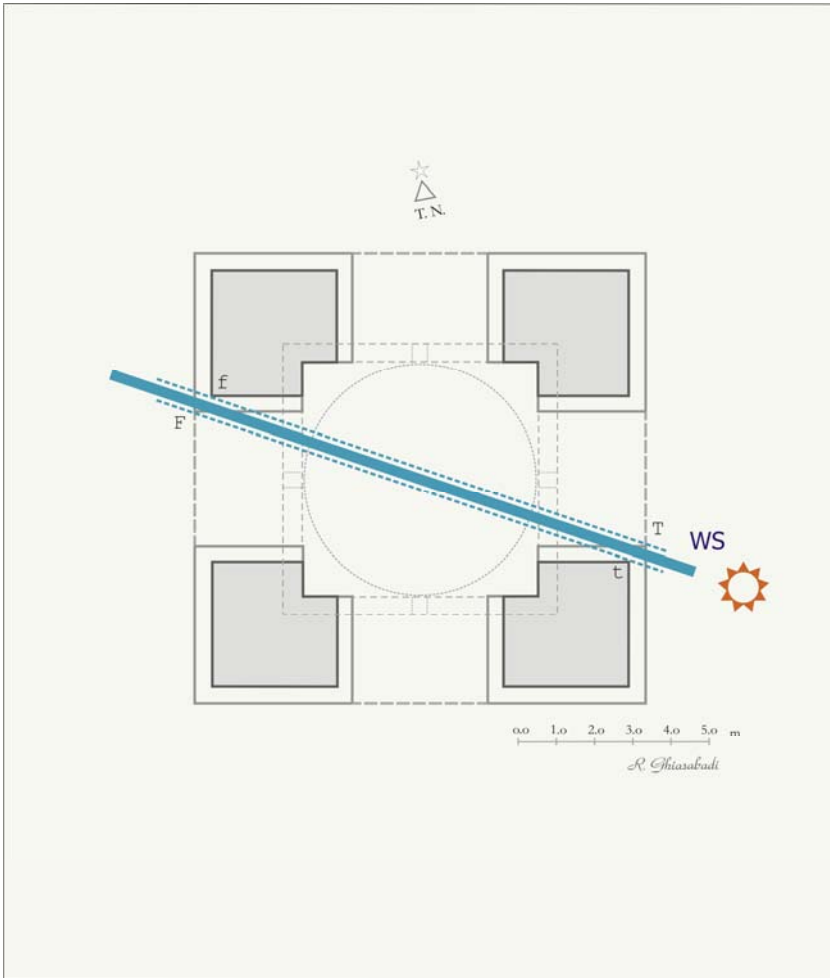

Figure 3.9: The sightline of sunrise in the winter solstice

The Sun in Tetrapylons



Figure 3.10: Sunrise in the winter solstice: the sightline is WS in Figure 3.9, around 2 minutes after the sunrise. The sun's altitude is 2 degrees above the horizon.

The Sun in Tetrapylons



Figure 3.11: Sunrise in the winter solstice: the sightline is WS in Figure 3.9, around 2 minutes after the sunrise. The sun's altitude is 2 degrees above the horizon.

The Sun in Tetrapylons

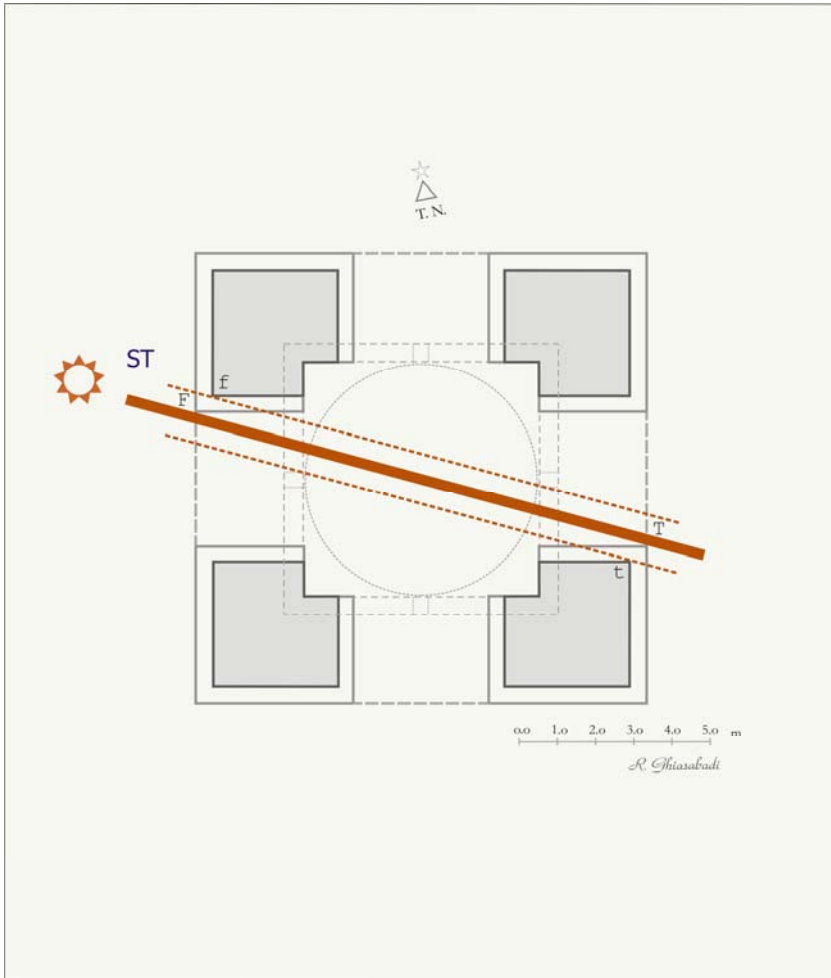

Figure 3.12: The sightline of sunset in the summer solstice

The Sun in Tetrapylons



Figure 3.13: Sunset in the summer solstice: the sightline is ST' in Figure 3.12, around 10 minutes before the sunrise. The sun's altitude is 10 degrees above the horizon.

The Sun in Tetrapylons

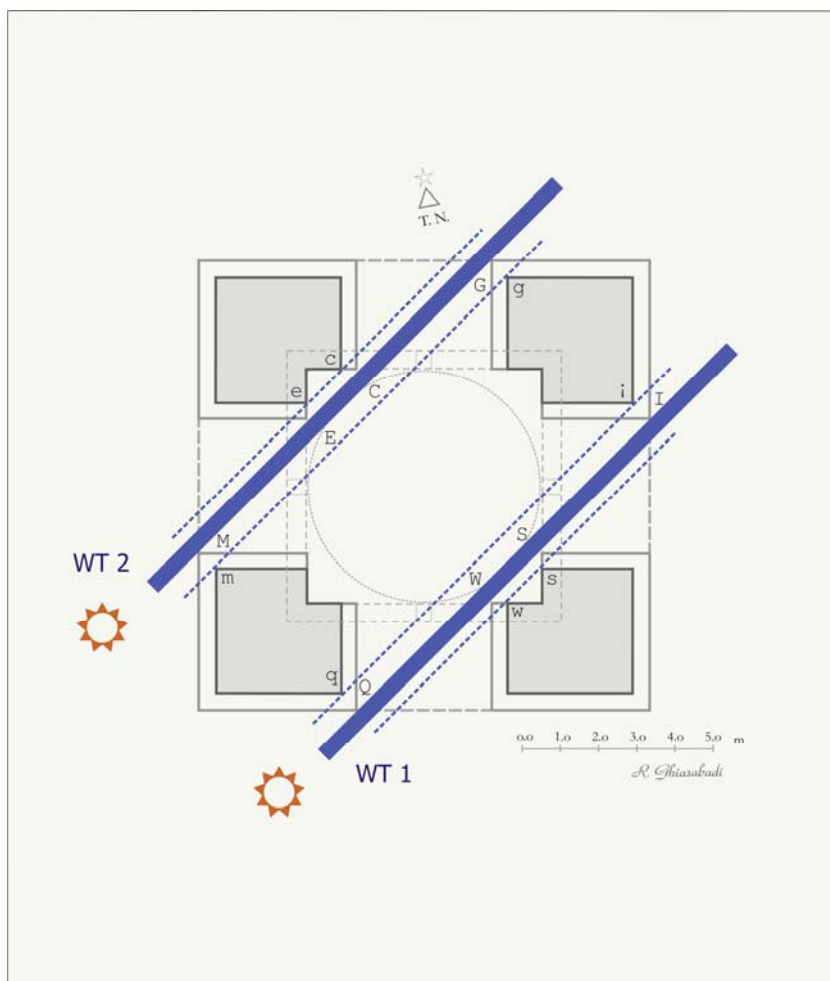

Figure 3.14: Double sightlines of sunset in the winter solstice: The sightlines are parallel to the diagonal of the tetrapylon.

The Sun in Tetrapylons



Figure 3.15: Sunset in the winter solstice: the sightline is WT 1 in Figure 3.14, around 2 minutes before the sunset. The sun's altitude is 7 degrees above the horizon.

The Sun in Tetrapylons



Figure 3.16: The sun's glory in Niasar Tetrapylon

The Sun in Tetrapylons



Figure 3.17: Visitors of the summer solstice in Niasar Tetrapylon, 2007



Figure 3.18: Visitors of the winter solstice in Niasar Tetrapylon, 2007

The Sun in Tetrapylons

4 Botkhaneh Tetrapylon

The other name: Atashkuh Tetrapylon

Location: The hillside of Mount Atashkuh, Botkhaneh Village, 16 kilometers southwest of Delijan City, 250 kilometers southwest of Tehran, Iran

Geographic coordinates: 33° 33.9' north latitude and 50° 38' east longitude

Note: There is an *ivan-like* structure in the northwest side of the tetrapylon. This structure has been built in recent centuries and does not have any relationship with the main structure of the tetrapylon.

The Sun in Tetrapylons



Figure 4.1: Botkhaneh Tetrapylon, the northeastern view

The Sun in Tetrapylons



Figure 4.2: Botkhaneh Tetrapylon, the northeastern pillar

The Sun in Tetrapylons

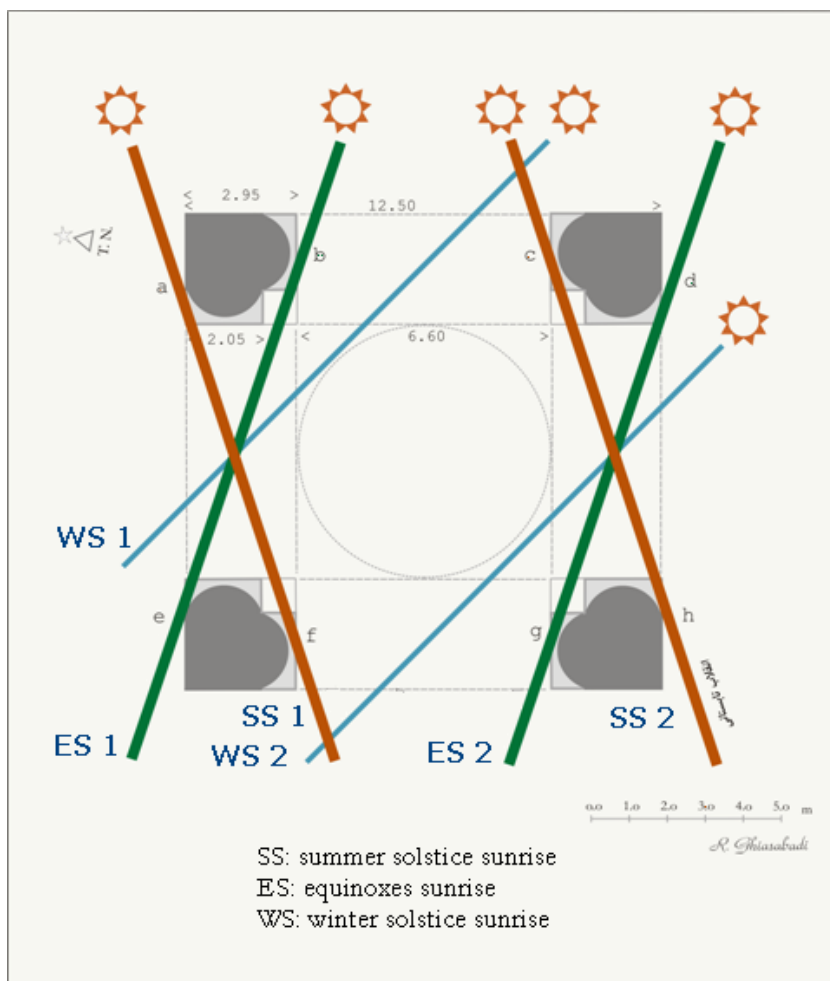

Figure 4.3: The floor plan and sightlines of Botkhaneh Tetrapylon

The Sun in Tetrapylons



Figure 4.4: Botkhaneh Tetrapylon, sunrise in the winter solstice

The Sun in Tetrapylons



Figure 4.5: Botkhaneh Tetrapylon: sunrise in the vernal equinox (Nawruz which is the name of the new year in the Persian Calendar)



Figure 4.6: Botkhaneh Tetrapylon, the northern view

The Sun in Tetrapylons

5 Nevis Tetrapylon

The other name: Borzu Tetrapylon

Location: Nevis Village, 17 kilometers northeast of Tafresh (in a straight line), 180 kilometers southwest of Tehran, Iran

Geographic coordinates: 34° 44.1' north latitude and 50° 11.48' east longitude



Figure 5.1: Nevis Tetrapylon, the western view

The Sun in Tetrapylons



Figure 5.2: Nevis Tetrapylon, the western view



Figure 5.3: Nevis Tetrapylon, sunrise in the vernal equinox

The Sun in Tetrapylons

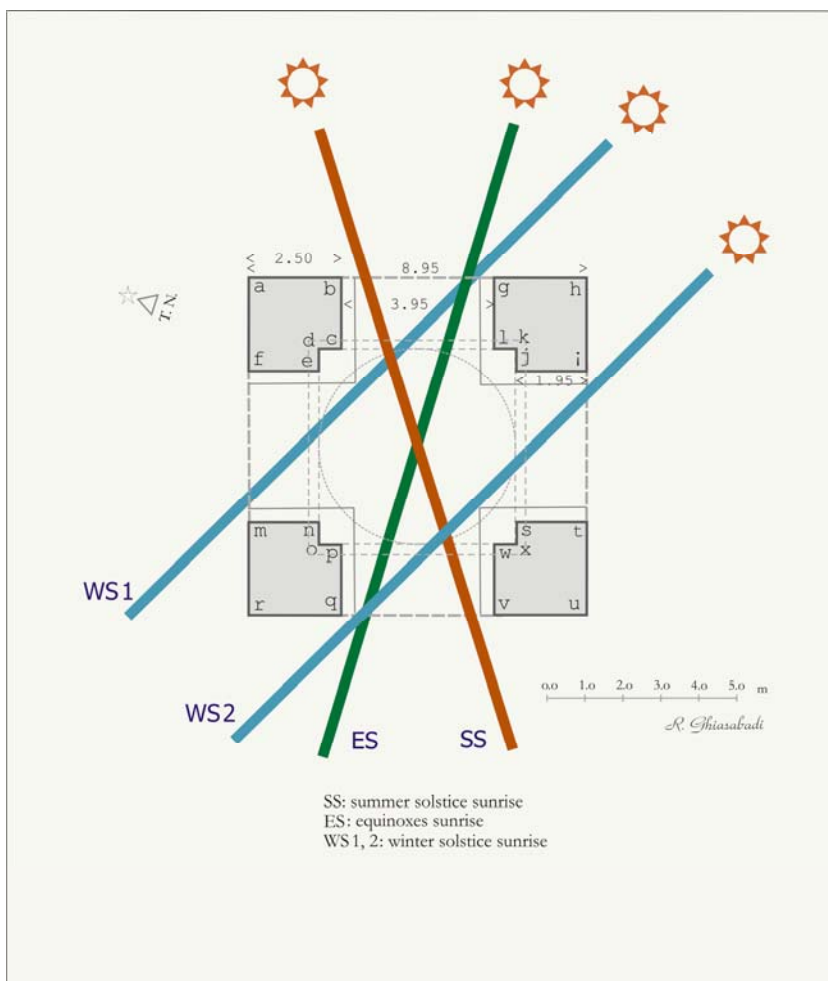

Figure 5.4: The floor plan and sightlines of Nevis Tetrapylon

The Sun in Tetrapylons



Figure 5.5: Nevis Tetrapylon, sunrise in the summer solstice



Figure 5.6: Nevis Tetrapylon, sunrise in the winter solstice

The Sun in Tetrapylons

6 Kheyraabad Tetrapylon

Location: Next to the Kheyraabad River, 35 kilometers east of Behbahan, Iran

Geographic coordinates: $30^{\circ} 31.5'$ north latitude and $50^{\circ} 30.5'$ east longitude



Figure 6.1: Kheyraabad Tetrapylon, the southwestern view

The Sun in Tetrapylons

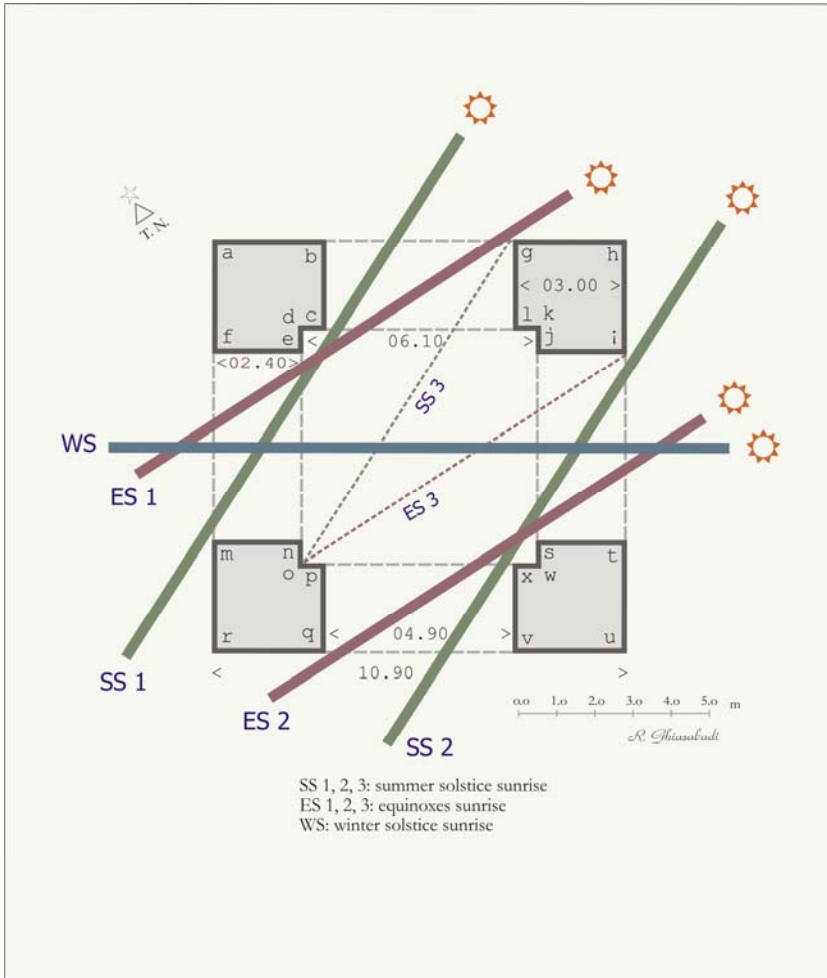

Figure 6.2: The floor plan and sightlines of Kheyraabad Tetrapylon

The Sun in Tetrapylons

7 Kermejegan Tetrapylon

Location: Kermejegan Village, 10 kilometers south of Kahak City, 50 kilometers south of Qom, Iran

Geographic coordinates: 34° 17.4' north latitude and 50° 49.5' east longitude



Figure 7.1: Kermejegan Tetrapylon, the southwestern view

The Sun in Tetrapylons

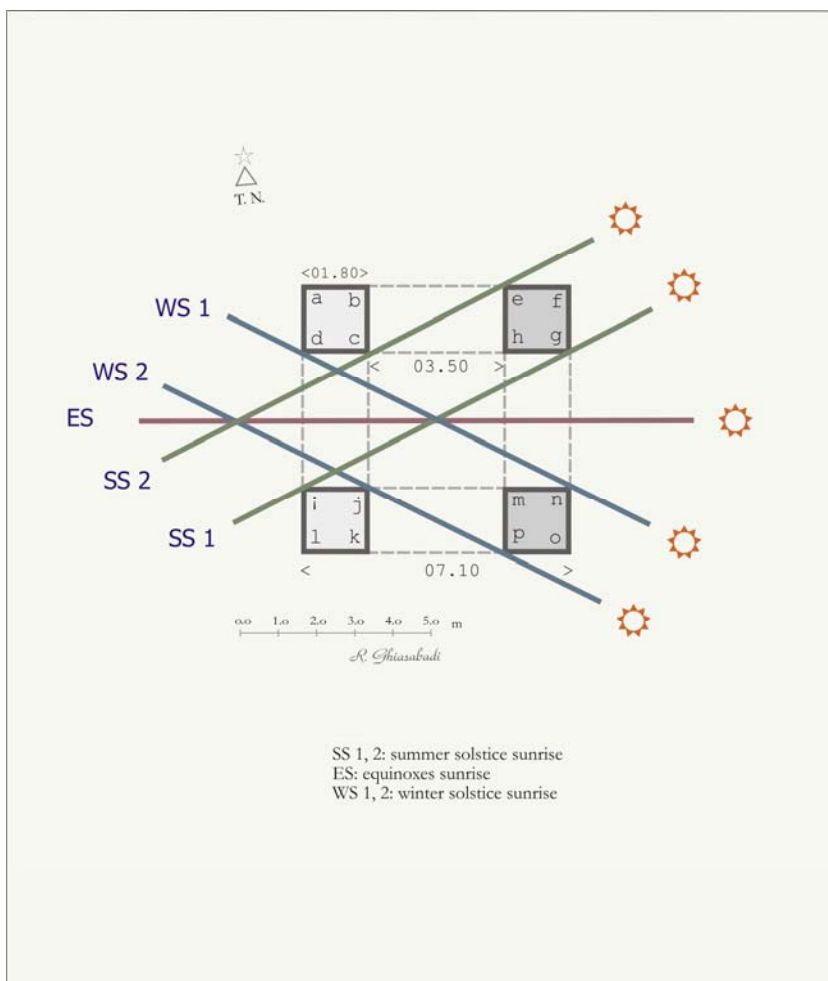

Figure 7.2: The floor plan and sightlines of Kermejejan Tetrapylon

The Sun in Tetrapylons

8 Kahak Tetrapylon

Location: Kahak City, 40 kilometers south of Qom, Iran

Geographic coordinates: 34° 24.1' north latitude and 50° 51.3' east longitude

Note: The tetrapylon has become a shrine throughout history.



Figure 8.1: Zeinab Khatun Shrine: the southwestern side of the tetrapylon that its spans have been filled.

Photo by an unknown photographer, 1974

The Sun in Tetrapylons



Figure 8.2: Zeinab Khatun Shrine

The Sun in Tetrapylons

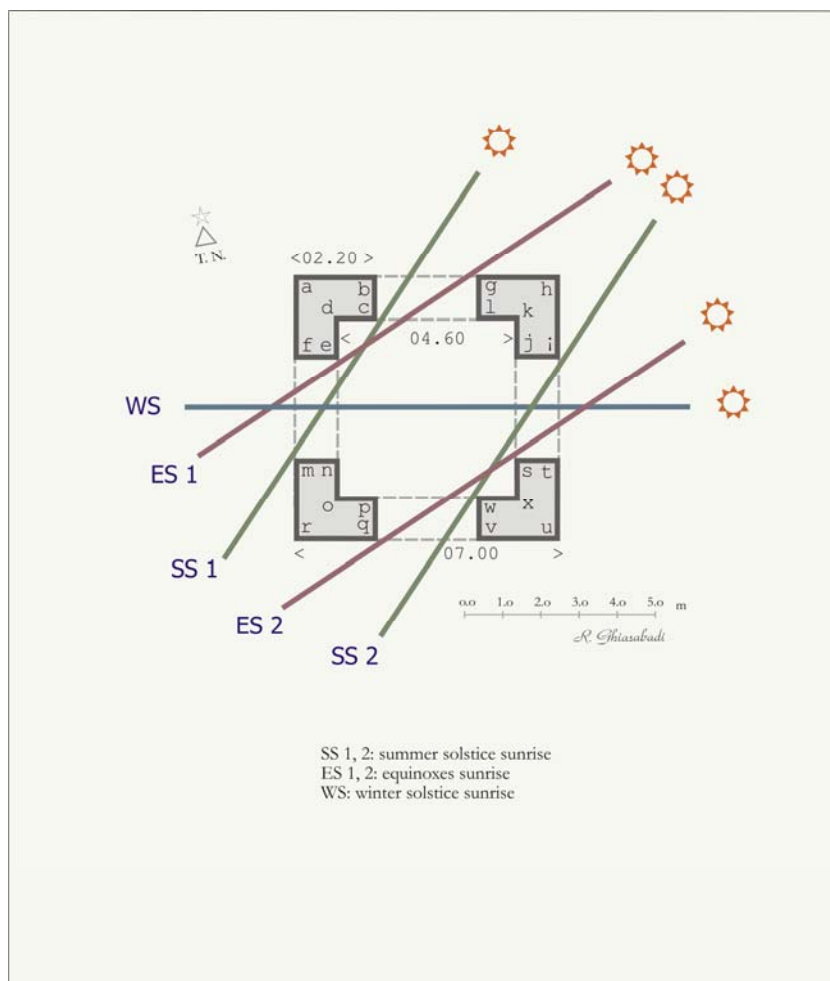

Figure 8.3: The floor plan and sightlines of Kahak Tetrapylon

The Sun in Tetrapylons



Figure 8.4: The pillars of the tetrapylon as well as Zeinab Khatun Shrine

The Sun in Tetrapylons

9 Khworabad Tetrapylon

Location: 15 kilometers south of Qom, Iran

Geographic coordinates: $34^{\circ} 30.3'$ north latitude and $51^{\circ} 01.2'$ east longitude

Note: Nowadays, only part of a pillar has remained.



Figure 9.1: Khworabad Tetrapylon

The Sun in Tetrapylons

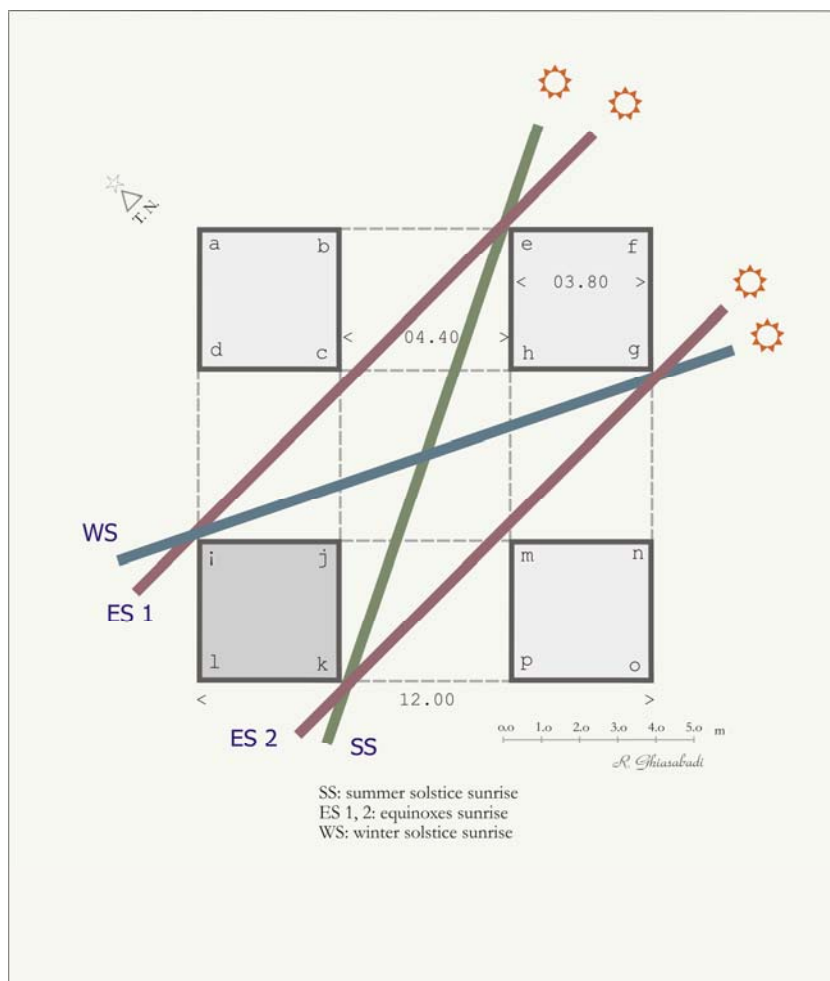

Figure 9.2: The floor plan and sightlines of Khworabad Tetrapylon

The Sun in Tetrapylons

10 Khaneh-e Div Tetrapylon

Location: Northwestern mountains of Sabzevar City, Iran

Geographic coordinates: 36° 20' north latitude and 57° 21' east longitude



Figure 10.1: Khaneh-e Div Tetrapylon
Photo courtesy of Jamal ad-Din Fereshteh Kheslat

The Sun in Tetrapylons



Figure 10.2: Khaneh-e Div Tetrapylon

The Sun in Tetrapylons

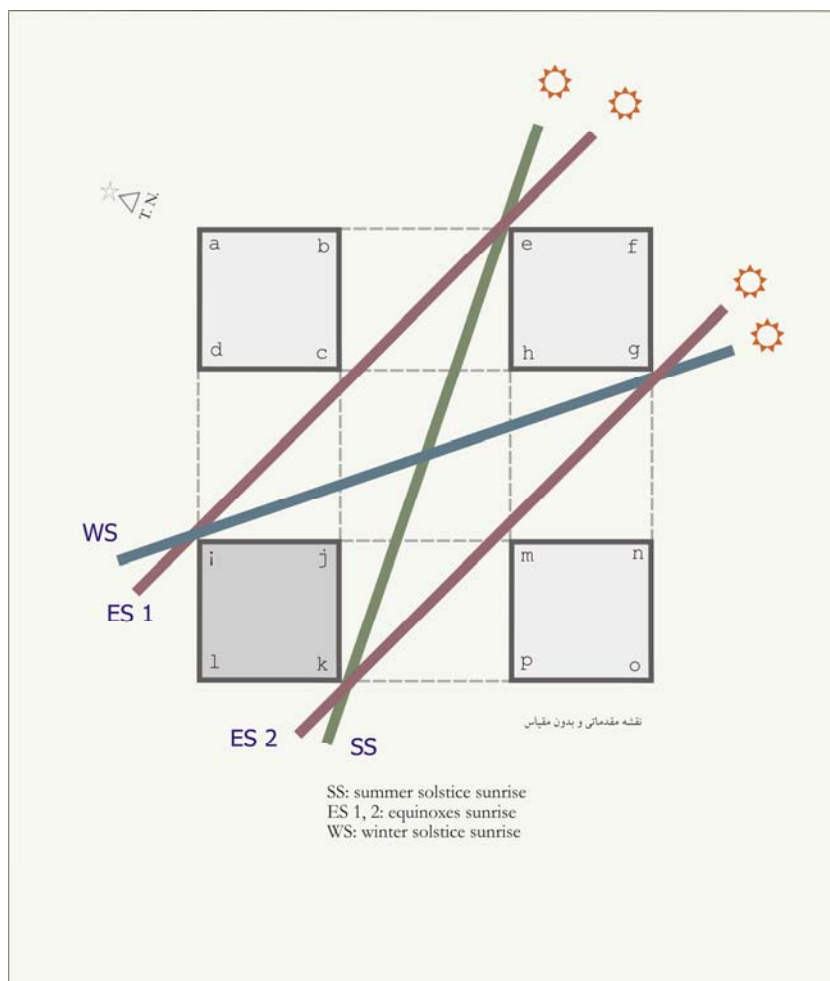

Figure 10.3: The floor plan and sightlines of Khaneh-e Div Tetrapylon

The Sun in Tetrapylons



Figure 10.4: Khaneh-e Div Tetrapylon, sunrise in the summer solstice: the sightline is SS in Figure 10.3.

The Sun in Tetrapylons

11 Photos of Some Other Tetrapylons



Figure 11.1: Jerch Tetrapylon, Farashband
Photo courtesy of Mohsen Abbaspour

The Sun in Tetrapylons



Figure 11.2: Jereh Tetrapylon, Farashband, sunrise in the winter solstice
Photo courtesy of Mohsen Abbaspour

The Sun in Tetrapylons



Figure 11.3: Bor-Cheshmeh Tetrapylon, Farashband

The Sun in Tetrapylons



Figure 11.4: Aviz Tetrapylon, Farashband



Figure 11.5: Naqqareh-Khaneh Tetrapylon, Farashband

The Sun in Tetrapylons



Figure 11.6: Kazerun Tetrapylon

The Sun in Tetrapylons



Figure 11.7: Mil-Milunch Tetrapylon, City of Nimeh Var

The Sun in Tetrapylons



Figure 11.8: Mosalla Tetrapylon, Yazd

The Sun in Tetrapylons



Figure 11.9 and 11.10: Bazeh-e Hur Tetrapylon, Neyshabur: the tetrapylon is located on the left side of the Neyshabour road to Torbat-e Heydariieh, after the village of Robat Sefid.

The Sun in Tetrapylons



Figure 11.11: Kushk Tetrapylon, Natanz

The Sun in Tetrapylons

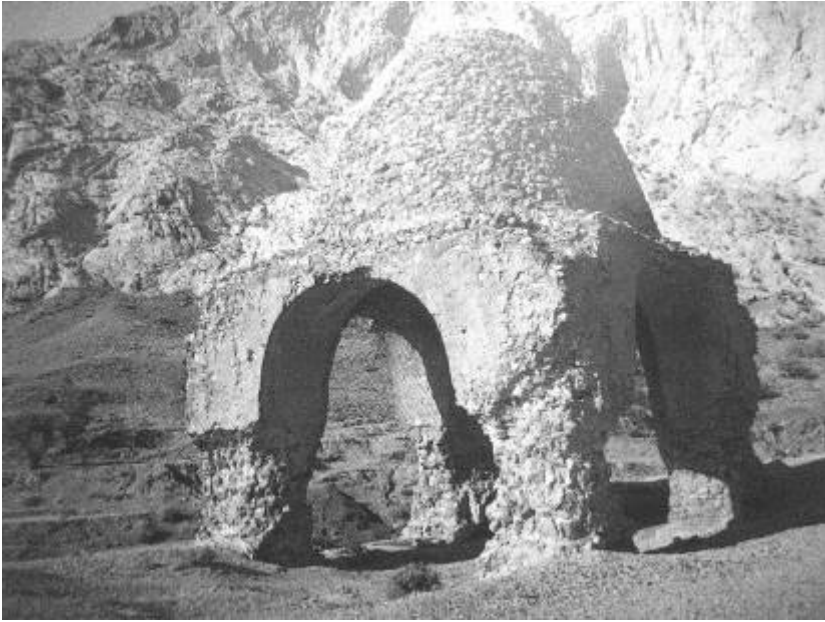

Figure 11.12: Chardari (Sepru/Pasru) Tetrapylon, Nayin
Photo courtesy of Jamal ad-Din Fereshteh Kheslat

The Sun in Tetrapylons



Figure 11.13: Gahvareh Did Tetrapylon, Shiraz

Part II
The Roman Tetrapylons

12 Preface to the Second Part

Since ten years ago, I have conducted comprehensive studies on the Persian tetrapylons such as Niasar, Botkhaneh, Nevis, Kheyraabad, Kahak, Khaneh-e Div, Kermejegan, Khworabad Tetrapylons, as well as about twenty others. These studies remove the veil of mystery from the features of the Persian tetrapylons and the principles used in their construction. As mentioned before, these principles are relevant to time, the solar annual motion, and the variation in the sun's declination. Consequently, we recognized the functionality and potential of the tetrapylons as solar structures and solar indicators to measure time or record ritual time in the structure.

Calling the Persian tetrapylons as fire temples was like a dark screen that prevented more necessary researches and access to realities; therefore, researchers were greatly misled. In 2001, I proposed this theory that the Persian tetrapylons should be studied in terms of solar investigations and their possible relationships with the solar annual motion. The theory was a novel view which revealed observable facts on tetrapylons and made a new insight into all ancient buildings.

In recent years, some people who are interested in Persian archaeoastronomy and solar structures followed up this new insight with my cooperation and supervision. Meanwhile, these researchers could achieve satisfactory results, so they try to complete their studies with patience and perseverance.

During the studies, some questions appeared about the existence of similar tetrapylons out of the Territories of the Persian's

The Sun in Tetrapylons

civilization and culture, particularly in the Roman Empire, so if there are such buildings, they have been constructed under the effects of Persian science and culture or vice versa?

A friend of mine Reza Assasi who is a PhD student in architecture in McGill University, selected the mentioned questions as the topics for his PhD research project based on studying the remaining structures of the ancient Roman Empire. He performed comprehensive studies and sent a lot of information. After communicating our ideas, we succeeded in getting good results.

Our researches show that there is a strong connection (with high accuracy) between the solar situation and Roman tetrapylons. On the contrary, the mentioned connection was not identified in the Roman triumphal arches; however, a weak relationship, which needs more extensive studies and bigger statistical populations, may exist between some Roman triumphal arches.

Today after identifying some western tetrapylons remaining from the Roman Empire and civilization, we assert that the first group of tetrapylons with calendrical functionality have been certainly identified in Europ and Mediterranean region, so our research on more tetrapylons continues.

I believe that as Persian tetrapylons helped to realize more knowledge on the Roman tetrapylons, special characteristics of the Roman tetrapylons can also help to discover unknown information about the Persian tetrapylons.

I am pleased that in the tenth anniversary of publishing the theory of solar relationships in the Persian tetrapylons, the initial report on the Roman tetrapylons is published herein.

13 Heidentor Tetrapylon

The other names: Pagan Gate and Heathen's Gate

Location: Roman City of Carnuntum, southwest of Vienna, Austria

Geographic coordinates: 46° 06' north latitude and 16° 51' east longitude

Age: The fourth century AD

Note: There are remnants of a pedestal at the center of the tetrapylon, that seems a statue was rested on it. Such a pedestal at the center of the building is an important characteristic not seen in the Persian tetrapylons; however, similar features could exist in the tetrapylons of Iran in the past. For instance, the Persian name of Botkhaneh which means the house of idol (statue), and it is the name of one of the Persian tetrapylons (mentioned on Page 34) supports this assumption. As it can be seen in Figure 13.3, during all seasons of the year, the sun's rays in a *cross-like* space created by the pillars circled the statue and revolved around it.

The Sun in Tetrapylons



Figure 12.1: Heidentor Tetrapylon
Photo courtesy of Reza Assasi



Figure 12.2: Reconstructed plan of Heidentor Tetrapylon
Photo by Helmreich Photography

The Sun in Tetrapylons

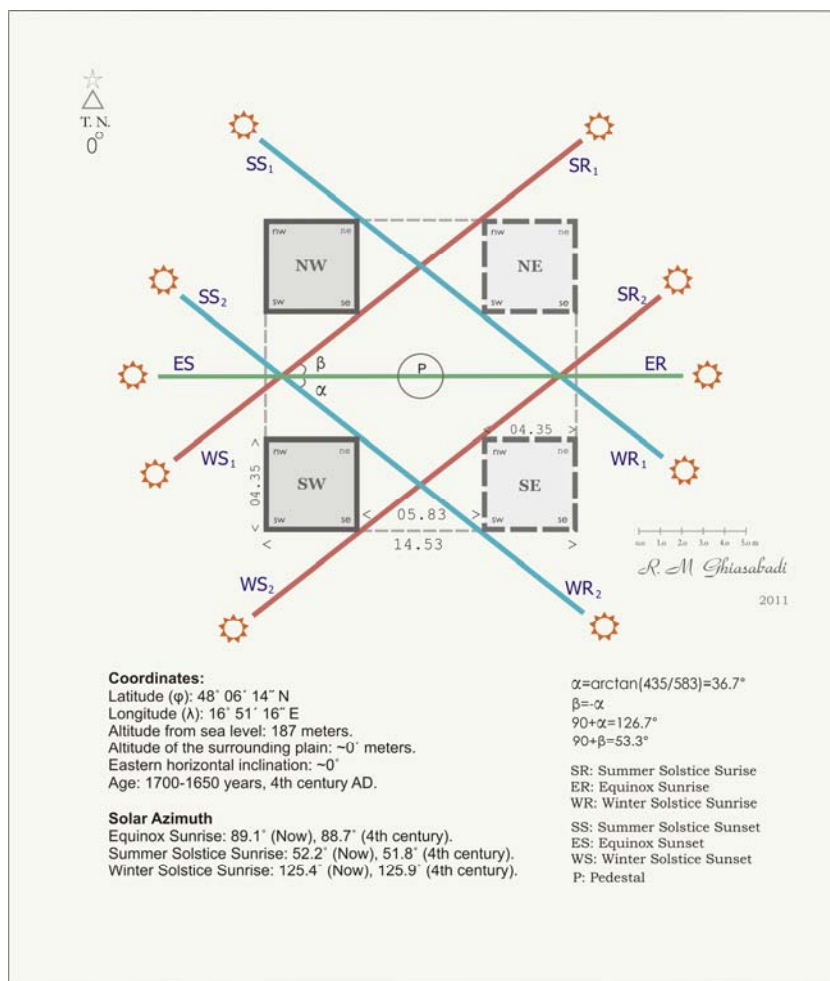

Figure 12.3: The floor plan and sightlines of Heidentor Tetrapylon

The Sun in Tetrapylons

14 Caparra Tetrapylon

The other name: Arc of Caparra

Location: The Roman City of Caparra, two kilometers from Casablanca, Spain

Age: The first or second century AD

Geographic coordinates: 40° 10' north latitude and 06° 06' west longitude



Figure 13.1: Caparra Tetrapylon
Source: guijodegranadilla.com/caparra.htm

The Sun in Tetrapylons

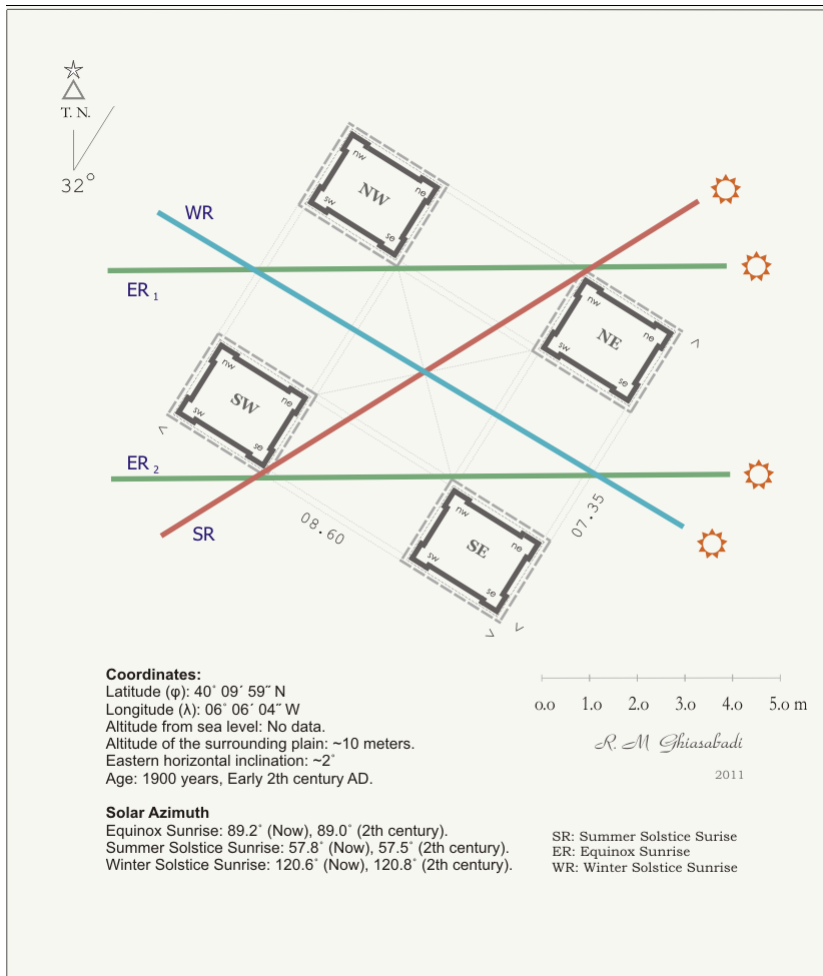

Figure 13.2: The floor plan and sightlines of Caparra Tetrapylon

The Sun in Tetrapylons

15 Janus Tetrapylon

The other names: Arc of Janus and Ianus Tetrapylon

Location: The Velabrum district, Rome, Italy

Age: The fourth century AD

Geographic coordinates: 41° 53' north latitude and 12° 29' east longitude



Figure 14.1: Janus Tetrapylon, 1870
Source: American Academy in Rome

The Sun in Tetrapylons

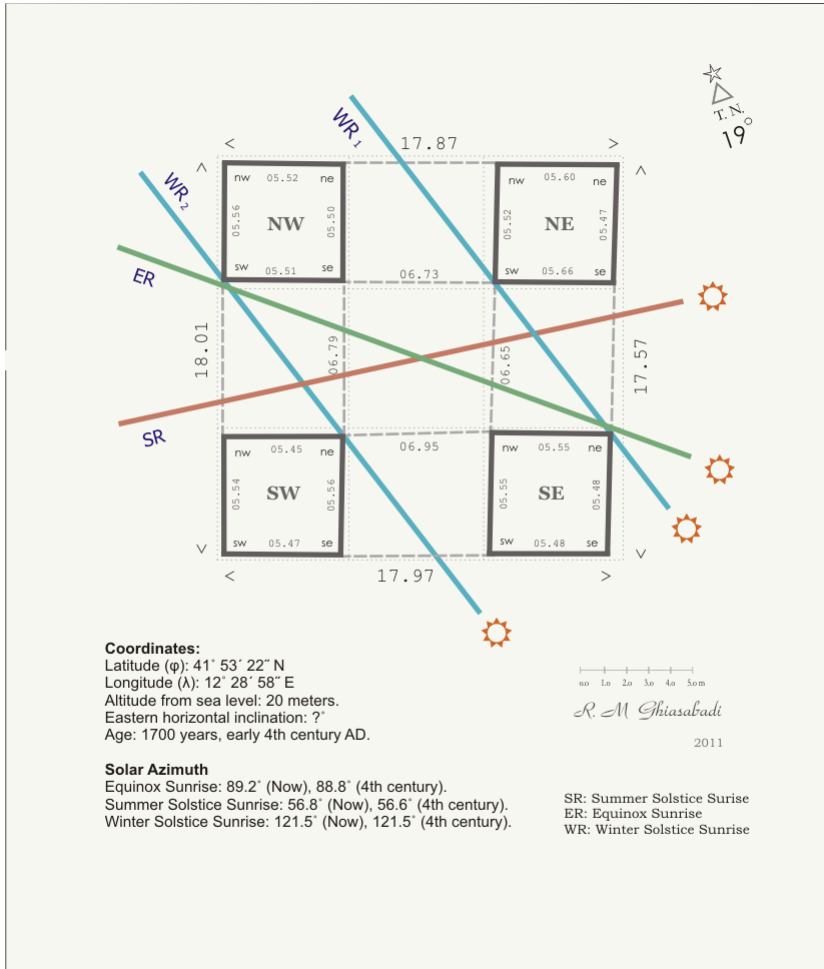

Figure 14.2: The floor plan and sightlines of Janus Tetrapylon

The Sun in Tetrapylons

16 Malborghetto Tetrapylon

The other names: Arch of Malborghetto and Arch of Divi Costantini

Location: 30 kilometers north of Rome, 20 kilometers south of Via Flaminia, Italy

Age: The fourth century AD

Geographic coordinates: 42° 03' north latitude and 12° 29' east longitude

Note: The building was changed between the thirteenth century and the sixteenth century. Other extensions were built around Malborghetto Tetrapylon and on its top, and the tetrapylon was used as a farm house. These extensions still exist and surround the main structure.

The Sun in Tetrapylons



Figure 15.1: Malborghetto Tetrapylon



Figure 15.2: Reconstructed plan of Malborghetto Tetrapylon, by Fritz Toebelman
based on a plan by Giuliano da Sangallo
Source: lazioturismo.it/asp/scheda_archeo.asp?id=59

The Sun in Tetrapylons

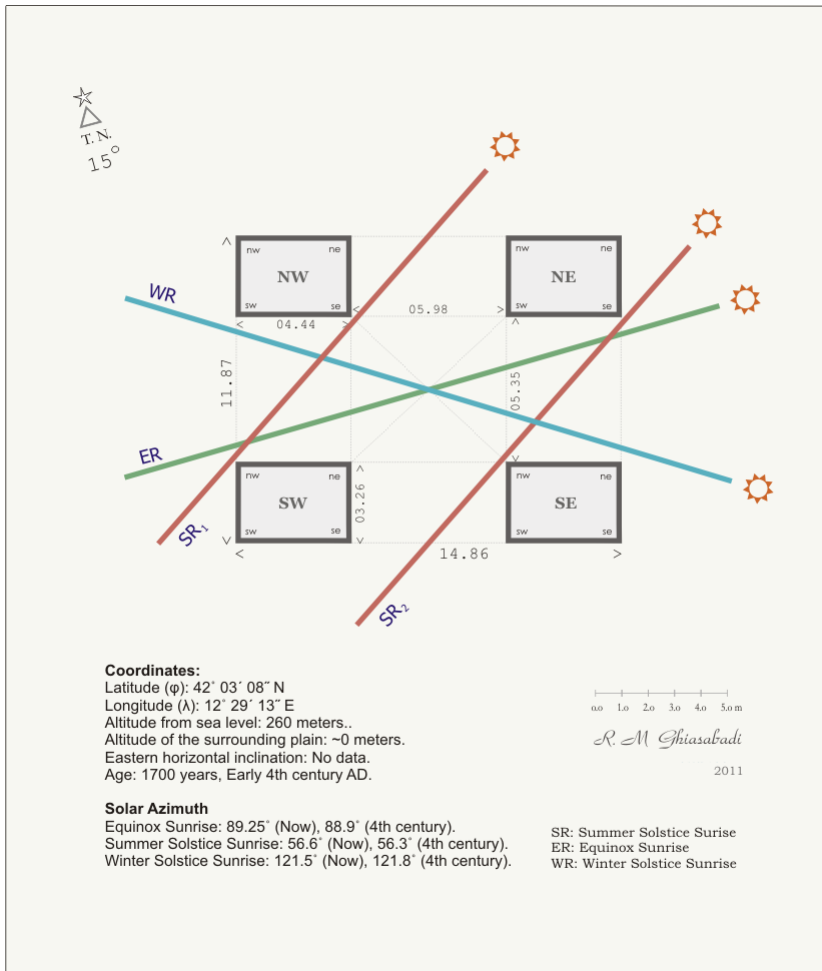

Figure 15.3: The floor plan and sightlines of Malborghetto Tetrapylon

Appendix

The Sun in Tetrapylons



Figure A: A scale model of a tetrapylon, about 2000 years ago, found in the ancient city of Hatra, Iraq

The Sun in Tetrapylons

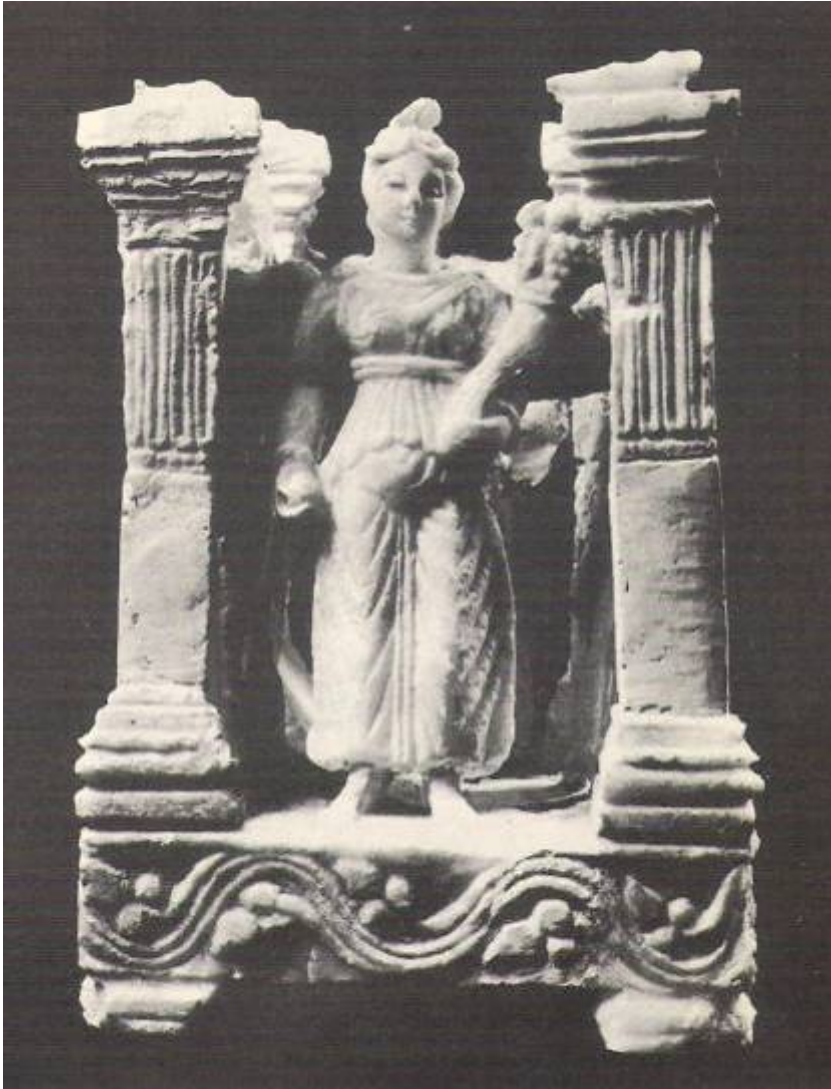

Figure B: A scala model of a tetrapylon, about 2000 years ago, found in the ancient city of Hatra, Iraq

**Get more e-books from www.ketabton.com
Ketabton.com: The Digital Library**